

MCB-377

HID CONTROLLER FOR ANALOG JOYSTICK

This controller allows to connect an analog joystick to a PC computer with USB interface Windows 98, Me, 2000, XP, Vista, Seven, Linux, ..., and to a MAC computer with OS8.6 or more.

No additional software is necessary.

MCB-377 can be used as

- **a Game controller** : 1 to 4 axis (Y, X, Z, Ry)
- **a Mouse pointer** : 2 axis + 1 wheel

MCB-377 makes the acquisition of

- 1 to 4 analog inputs for the axis on 10 bits with or without central dead zone ($\pm 5\%$)
- 8 independent push buttons or 16 push buttons in matrix 4x4.

The product is powered directly by the USB interface.

Please, consider all connectors with the pitch of 2.54 mm.

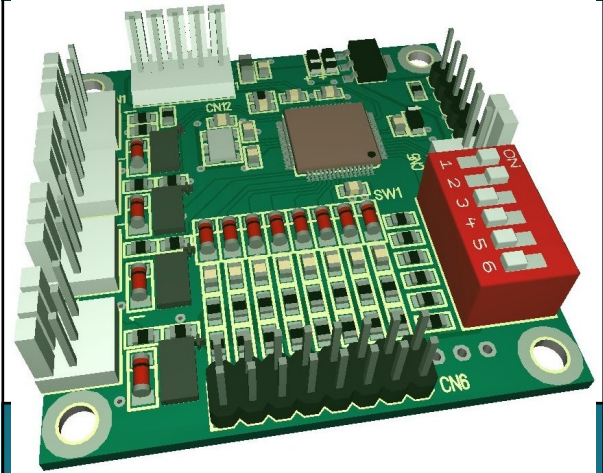

8 INDEPENDENT PUSH BUTTONS OR
16 PUSH BUTTONS IN MATRIX

- FULLY REPROGRAMMABLE BY THE USER
WITHOUT NEED OF ANY SOFTWARE
- USB INTERFACE

Reference	Hardware description	Factory Programming
MCB-377	4 axis 8 independent push buttons or 16 push buttons in matrix 4x4	4 axis with central dead zone 8 independent push buttons

Switch	Description	OFF	ON
SW1	Prog. Validation	Short pulse ON enables 1 of the 3 programming modes. See SW2 / SW3	
SW2	Programming mode Prog. #1	Disabled	Axis Buttons Factory
SW3	Programming mode Prog. #2	OFF ON	OFF ON
SW4	Push-buttons mode	Independents	In matrix (4x4)
SW5	Central Dead Zones	Defined axis by axis when programming	None, Linear mode
SW6	HID mode	Game controller	Mouse

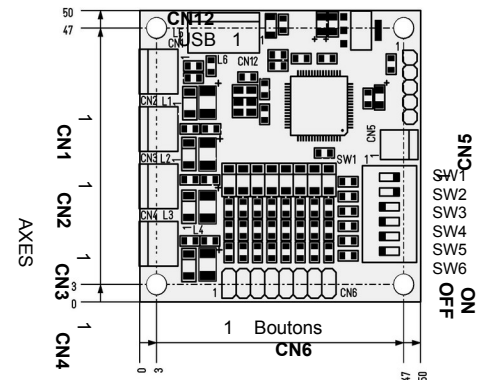

Dimensions of the board
values are given in mm

HID mode output USB

CN5	Name	Description
1	HID mode	Input
2	GND	Ground

CN5 connector is a repeat of the DIL SW6. SW6 must be set to OFF to use CN5 as the HID selection input:
Open: Joystick / Closed: Mouse

CN12	Name	Description
1	5V DC	Power + (red)
2	D-	Data - (white)
3	D+	Data + (green)
4	GND	Ground (black)
5	SHD	Ground shield

The 3 first axis and 3 first buttons are switched on the fly between the two operating modes Joystick and mouse.

Axes

Each of the 4 axis has its own connector (CN1 to CN4).
The choice of the connector used for each axis is irrelevant.
The order of the axes is defined during programming !

CN1 to 4	Name	Description
1	VCC	Power (from MCB-377)
2	Signal	Analog Input
3	GND	Ground (from MCB-377)

VCC can be DC 5V or DC 3.3V (selected with bridges L5 and L6).; it is defined for all the 4 axis. It is **not** possible to use together Potentiometers and DC 5V analog inputs. Depending of the input connected on CN1 to CN4, the corresponding bridge (L1 to L4) must be opened or closed. See drawings ...

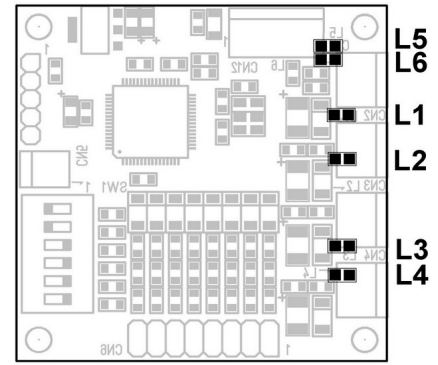
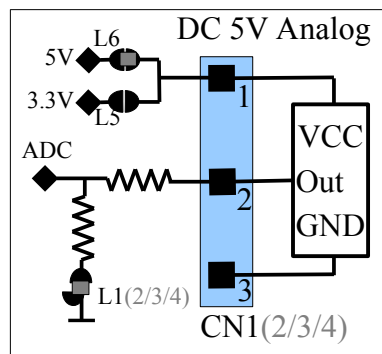
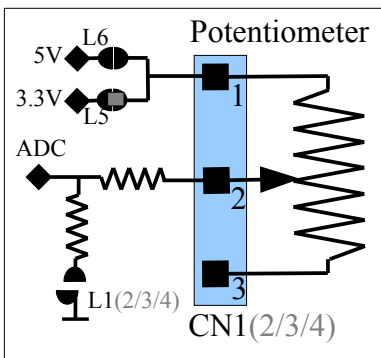

Bridges on solder side

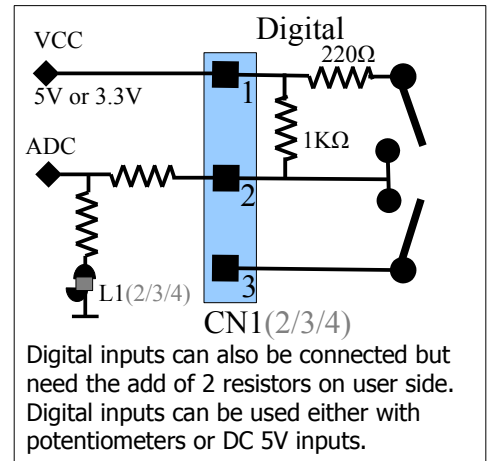

Push-Buttons

Push buttons must be connected to CN6 connector.

Name	CN6	Name	Description
GND	1	2	BR1 Push-button Input 1 or Raw Output 1
GND	3	4	BR2 Push-button Input 2 or Raw Output 2
GND	5	6	BR3 Push-button Input 3 or Raw Output 3
GND	7	8	BR4 Push-button Input 4 or Raw Output 4
GND	9	10	BC1 Push-button Input 5 or Column Input 1
GND	11	12	BC2 Push-button Input 6 or Column Input 2
GND	13	14	BC3 Push-button Input 7 or Column Input 3
GND	15	16	BC4 Push-button Input 8 or Column Input 4

During configuration :

- if SW4 is OFF, the push-buttons are independents: wiring is easier with a maximum of 8 push-buttons
- if SW4 is ON, the push-buttons are in matrix mode wiring: a diode must then be added in series with each button, cathode on the input side, to avoid "phantom" buttons when simultaneously pressing several buttons.

Example of wiring of independent buttons

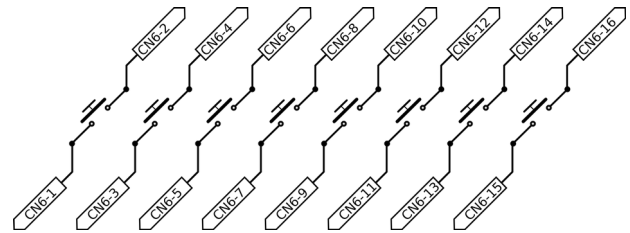

It is possible to connect up to 8 buttons between the « input buttons » CN6-2/4/6/8/10/12/14/16 and the ground GND CN6-1/3/5/7/9/11/13/15

Example of wiring of buttons in matrix

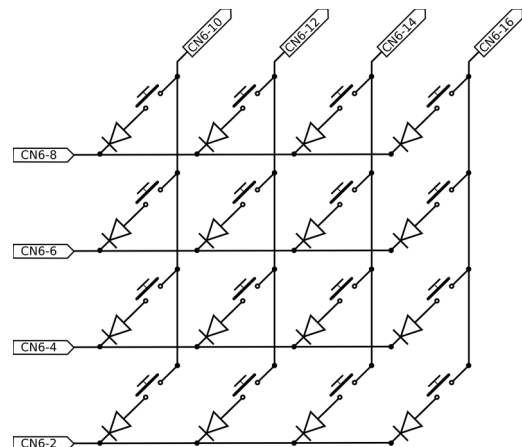

It is possible to connect up to 16 buttons between the 4 output raws CN6-2 / 4 / 6 / 8 and the 4 input columns CN6-10/12/14/16

Programming

MCB-377 is fully reprogrammable without any special software installation :

It is possible to repeat the programming as many times as necessary if the result does not suit you or if you are mistaken. If necessary, there is also a reset mode to the factory settings.

Axis programming mode

Activation

Set switches SW2 ON
and SW3 OFF

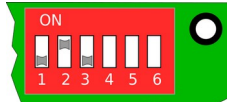

Move SW1 ON
for a short time (0.5 <-> 2 sec)



then move SW1 OFF



The MCB-377 automatically disconnects itself from this point from the USB connection. Configuration can begin.
The axis programming mode is activated.

Axis configuration

Select the axis order and orientation simply by moving the joystick axis in the order Y, X, Z, Ry

Note: each axis must be moved on its full range to obtain a good calibration of its entries.

The first direction chosen will be the increasing sense.

Example : First Y
*Careful : on computers, the increasing sense Y
is toward the bottom of the screen.
It is therefore necessary to manipulate
the Y axis in reverse direction !*

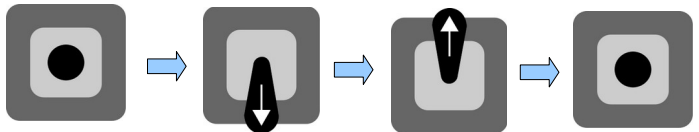

then X

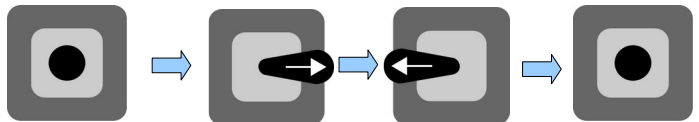

Do the same thing for the other axes Z and Ry.

*We advise you to put a jumper between pins 2 and 3
on the unused axis connectors during configuration.*

Programming validation

Finally, leave the axis in a rest position :



Axes in the middle
position will have a
central dead zone
(±5%) which will be
added if SW5 is OFF

or



Axes in mini or maxi
position will have **no**
central dead zone.

before resetting SW2 to OFF

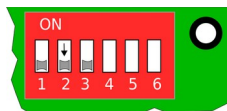

The new settings are saved in the Flash memory, then the MCB-377 automatically reconnects to the USB interface.
Programming is complete.

New: All central dead zones created during the axis programming
will be disabled when DIL SW5 is ON (Linear mode)

Buttons programming mode

Activation

Set switches SW2 OFF
and SW3 ON

Select wiring used
for the buttons with SW4

Move SW1 ON
for a short time (0.5 <-> 2 sec)

then move SW1 OFF

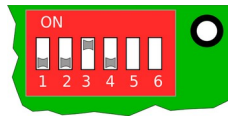

SW4:OFF Independents

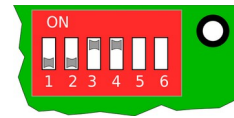

SW4:ON in Matrix

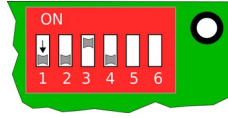
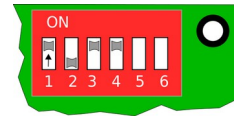
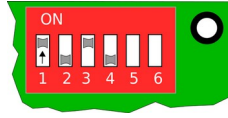

*The MCB-377 automatically disconnects itself from this point from the USB connection. Configuration can begin.
The buttons programming mode is activated.*

Buttons configuration

Select the push-buttons order simply by pushing them in the required order.
Here is a configuration example with 5 buttons :

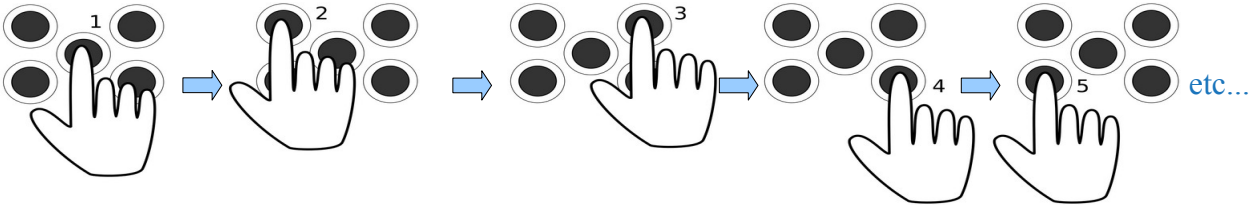

Programming validation

Reset SW3 to OFF

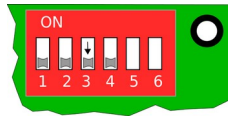

The new settings are saved in the Flash memory, then the MCB-377 automatically reconnects to the USB interface.
Programming is complete.

Restore Factory settings mode

Activation

Set switches SW2 ON
and SW3 ON

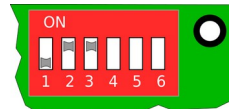

Move SW1 ON
for a short time (0.5 <-> 2 sec)

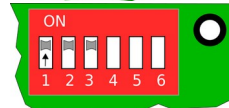

then move SW1 OFF



*The MCB-377 automatically disconnects itself from this point from the USB connection. Configuration can begin.
Restore to Factory settings mode is initialized.*

Restoration validation

Reset SW2 to OFF
and SW3 to OFF

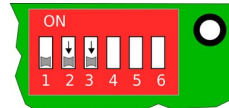

Factory settings are restored in Flash memory, then the MCB-377 automatically reconnects to the USB interface.
Restoration is complete.

Supplied accessories

- 4 x Crimp Housing, Molex KK 254, series 2695, ref : 22013037, 3 terminals
- 12 x Crimp terminals, Molex KK254, series 4809, ref : 08500031, 22-30 AWG
- 1 x Crimp Housing, Amphenol Dubox, series 65239, ref : 65239-008LF, 2x8 terminals
- 16 x Crimp terminals, Amphenol Dubox, series 76357, ref : 76357-401LF, 22-30 AWG
- 1 x USB Cable USB-A/5x2.54 female, length 1.5m